



belt design marco fumagalli 2023

modular sofa with metal frame covered with expanded polyurethane foam and two acrylic fiber layers. Wooden seat supported by elastic belts, covered with Polyurethane foam and acrylic fiber. The metal profile of the armrest is available in both polished and black chrome plated metal. Decorative leather belt available in the following colors: Ibiza 55, Setanil 78/75/76/10, Soffio 55. Legs in black painted wood.

divano modulare con fusto in metallo rivestito con poliuretano espanso e doppio strato di falda acrilica. Seduta in legno con supporto di nastri elastici, rivestita con poliuretano espanso e falda acrilica. Profilo bracciolo in metallo realizzabile con finitura cromata lucida o cromata nera. Cintura decorativa in pelle disponibile nei seguenti colori: Ibiza 55, Setanil 78/76/75/10, Soffio 55. Piedi in legno verniciato nero.

seat height altezza seduta 41 cm 16.1"	seat depth profondità seduta 64 cm 25.2"	arm width larghezza braccio 18 cm 7"	arm height altezza braccio 71 cm 27.9"	feet height altezza piede 4 cm 1.6"
--	--	--	--	---

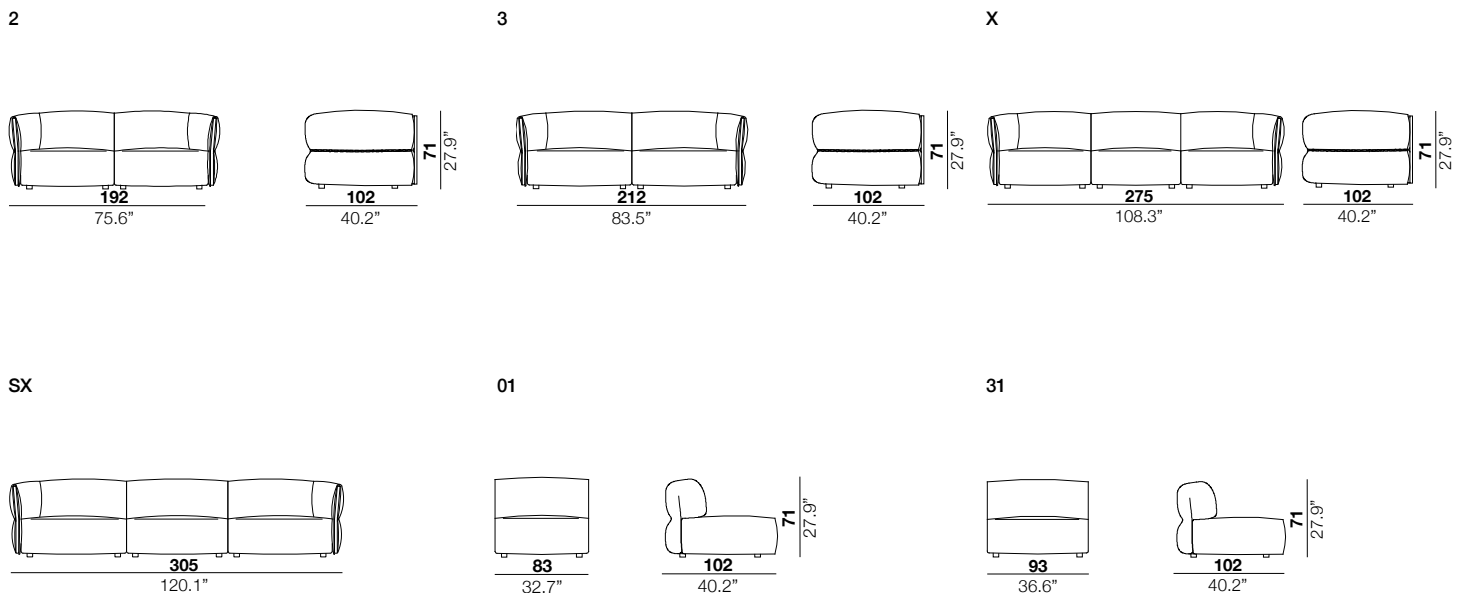
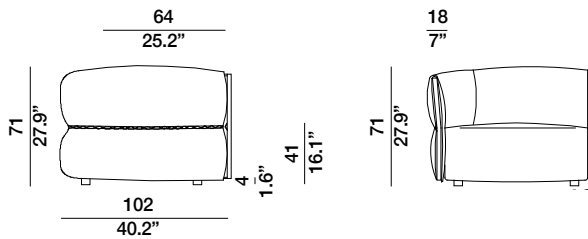

05/06

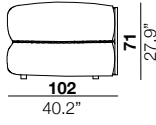
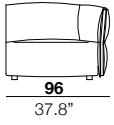
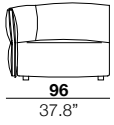

07/08

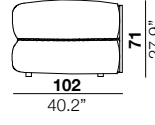
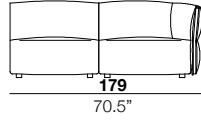
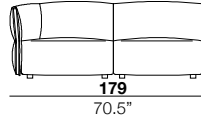

15/16

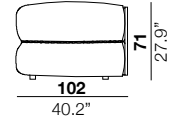
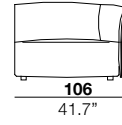
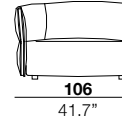

19/20

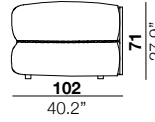
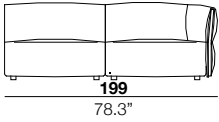
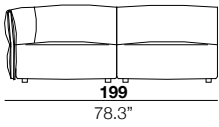

17/18

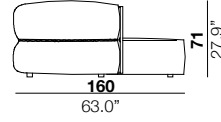
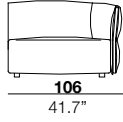
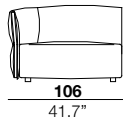

19+18

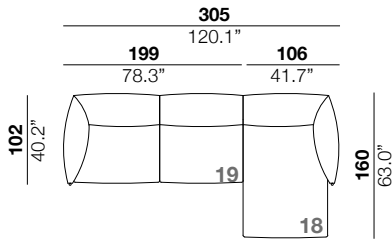

07+18

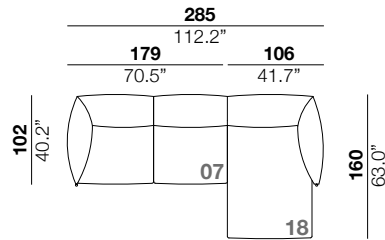

17+01+01+06

