



Quadrifoglio Group

FIVE

design living

www.quadrifoglio.com



WORKTOPS

25mm easy to clean scratch-resistant anti-reflective melamine faced chipboard (MFC) finished with 2mm matching straight ABS impact resistant edges. Panel density: 670/730 kgs per cubic meter

Finish options:

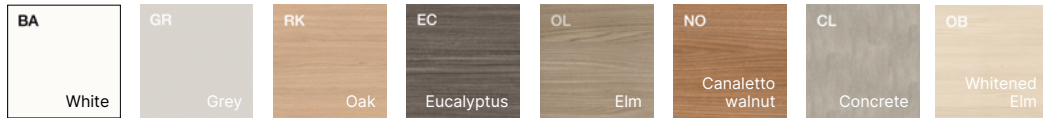

METAL FRAME

Epoxy powder coated steel frame.

Finish options:

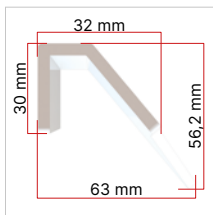

Tapered legs made of 4mm steel open sections, cross section tapers from 30×32mm (lower end) to 63×56.2mm (upper end)

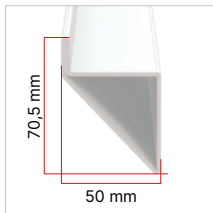

Crossbar between legs made of 50×70.5mm 2mm steel hollow tube, beams are fitted using steel brackets welded to crossbar

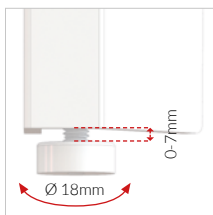

0-7mm adjustable levelling feet made of grey polyethylene, 18mm diameter

Specification sheet

FRAME

Legs and perimeter frame made from steel tubes linked together by die-cast zamak three-arm corner units. All parts supplied epoxy powder coated.

Finish options:

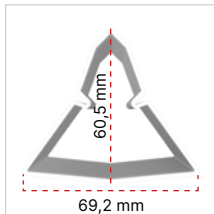
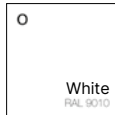

Legs made from 2mm triangle-shaped steel tube, 60.5×69.2mm section.

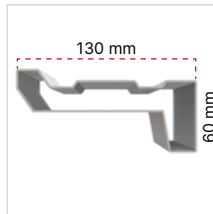

Perimeter frame made from 1.5m steel tube, 130×60mm section.

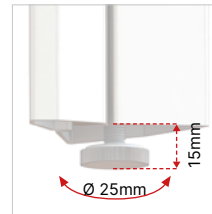

0-15mm adjustable levelling feet made of polyethylene, 25mm diameter.

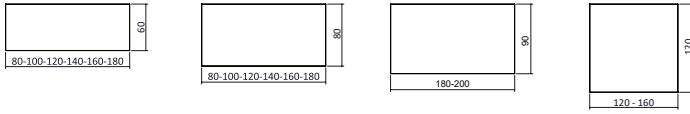



MATERIALS AND RECYCLABILITY

Panels used on FIVE range are exclusively 100% made by recycled wood and respect low formaldehyde emission (CATAS certification Quality Award CARB). Resins used on panels and melamine paper are SVHC substances free (reported on ECHA list update to 12/01/2017)

POST-CONSUMER
RECYCLABLE

Wood	100%
Plastic	100%
Metal	100%
Mixed	If disposed of in a specialised facilities

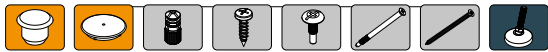
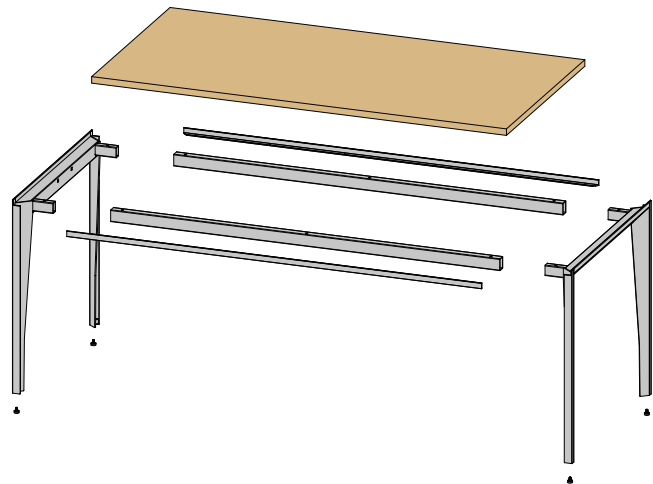



STANDARDS

FIVE range has passed the following tests, attested by **CATAS** analysis laboratory in San Giovanni al Natisone (UD).

- Tables and desks dimensions EN 527-1:2011
- Office work tables: safety requirements EN 527-2:2016+A1:2019 clause 4.1 - 4.2
- Office work tables: information for use EN 527-2:2016+A1:2019, clause 6
- Horizontal static load test EN 1730:2012, clause 6.2
- Vertical static load test EN 1730:2012, clause 6.3
- Horizontal fatigue test EN 1730:2012, clause 6.4.2
- Stiffness of the structure EN 1730:2012, clause 6.4.3
- Vertical fatigue test EN 1730:2012, clause 6.5
- Vertical impact test EN 1730:2012, clause 6.6
- Worktops bend EN 1730:2012, clause 6.7
- Drop test EN 1730:2012, clause 6.9
- Stability under vertical load EN 1730:2012, clause 7.2
- Legs impact UNI 9086:1987



CERTIFICATES

Constantly receptive to market requirements, Quadrifoglio Sistemi d'Arredo pay special attention on quality and safety contents in order to provide high products and services. The Company has reached certifications UNI EN ISO 9001/2015, UNI EN ISO 14001/2015 and UNI EN ISO 45001/2018 to confirm his policy. Our products are certified and ensured by FSC™ and ECOLOGICAL PANEL.

COMPANY WITH
MANAGEMENT SYSTEM
CERTIFIED BY DNV
ISO 9001 • ISO 14001
ISO 45001



GREEN ENERGY

The Company had installed the photovoltaic system with 4.500 solar panels in a 7.350 m² surface that covers almost entirely the factory. The photovoltaic is able to produce 1Mw of a quiet green energy, that does not harm the environment and is waste-free. With his high production capacity the photovoltaic allows us to reduce emissions in the atmosphere of all those polluting substances and to those that contribute to the greenhouse effects. Consequently, such measures make us save every year 180 tonne of petrol oil, 440 tonne of CO₂, 514kg of sulphur dioxide, 448 kg of nitrogen oxide and 23kg of dust.



TRANSPORT

Packaging is reduced in order to decrease volumes. Goods collections are responsibly managed and organised with the aim of optimise transports, reducing atmosphere emissions.