

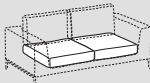

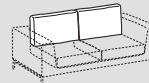

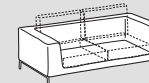







Kanaha 2.0 divano letto

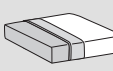

	 Seduta - Seat	 Schienali - Backrests	 Struttura - Structure
Rivestimento Upholstering (9)	Sfoderabile Removable  	Sfoderabile Removable  	Sfoderabile Removable  
	Non sfoderabile Not removable -	Non sfoderabile Not removable -	Non sfoderabile Not removable -
Imbottiture Padding (3-4-5-6-7)	 +  D.35kg/m³	 +  D.21kg/m³	 +  Tecnoform

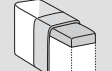
INFORMAZIONI TECNICHE

Struttura: 1-6

Telaio di base in acciaio verniciato. Masselli in abete di vari spessori, pannelli di tamponamento in pannelli di particelle di legno in classe E1, compensato o pannelli di fibra di legno dura o cellulosa.

Struttura rivestita completamente in lastre di poliuretano espanso e Tecnoform.

Molleggio: 1-2

Schienale in pannelli di particelle di legno in classe E1 e pannelli di fibra di legno dura o cellulosa.

Seduta in nastri elastici incrociati del meccanismo rete.

Note:

Per finitura bicolore ovvero scocca rivestita in tessuto o similpelle e cuscini della seduta, dei braccioli e dello schienale in tessuto considerare il prezzo della categoria più alta dei rivestimenti utilizzati.

Caratteristiche relative ai materiali utilizzati descritte nella sezione tecnica a fine listino.

TECHNICAL INFORMATION

Structure: 1-6

Supporting structure in polished steel, varnished with high resistance powders. Remaining parts in wooden E1 class agglomeration panels or cellulose agglomeration panels.

Structure completely covered with foam and Tecnoform.

Springing: 1-2

Backrest in class E1 particleboard panels and hard or cellulose wood fibre panels.

Seat in crisscross belts of the bed base mechanism.

Notes:

For two-colour finish, with frame upholstered in fabric or artificial leather and seat cushions, armrests and backrest in fabric, please consider the price of the more expensive category of covers used.

For characteristics related to the materials used, see the technical section at the end of the pricelist.

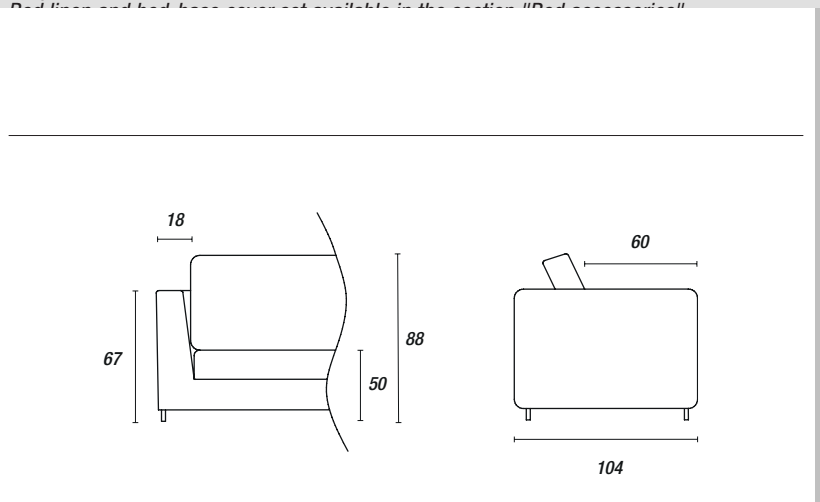
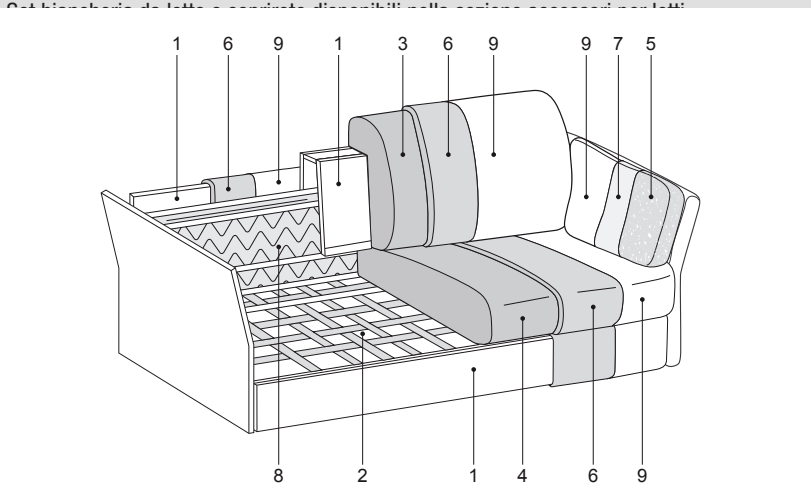

Kanaha mix 2.0 divano letto



	Seduta - Seat	Schienali - Backrests	Struttura - Structure	
Rivestimento Upholstering (9)	Sfoderabile Removable	Sfoderabile Removable	Sfoderabile Removable	
	Non sfoderabile Not removable	Non sfoderabile Not removable	Non sfoderabile Not removable	
Imbottiture Padding (3-4-5-6-7)	D.35kg/m³	D.21kg/m³		

INFORMAZIONI TECNICHE

Struttura: 1-6

Telaio di base in acciaio verniciato. Masselli in abete di vari spessori, pannelli di tamponamento in pannelli di particelle di legno in classe E1, compensato o pannelli di fibra di legno dura o cellulosa.

Struttura rivestita completamente in lastre di poliuretano espanso e Tecnoform.

Molleggio: 1-2

Schienale in pannelli di particelle di legno in classe E1 e pannelli di fibra di legno dura o cellulosa.

Seduta in nastri elastici incrociati del meccanismo rete.

Note:

Scocca rivestita in pelle Cat. Soft, per divano letto con parti in pelle di altre categorie aggiungere la maggiorazione indicata.

Caratteristiche relative ai materiali utilizzati descritte nella sezione tecnica a fine listino.

Set biancheria da letto e copirette disponibili nella sezione accessori per letti.

TECHNICAL INFORMATION

Structure: 1-6

Supporting structure in polished steel, varnished with high resistance powders. Remaining parts in wooden E1 class agglomeration panels or cellulose agglomeration panels.

Structure completely covered with foam and Tecnoform.

Springing: 1-2

Backrest in class E1 particleboard panels and hard or cellulose wood fibre panels.

Seat in crisscross belts of the bed base mechanism.

Notes:

Body covered in Cat. Soft leather; for sofa bed with leather parts from other categories, please add the indicated surcharge.

For characteristics related to the materials used, see the technical section at the end of the pricelist.

Bed linen and bed-base cover set available in the section "Bed accessories"

