

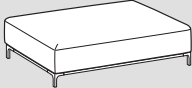







# Sanders air

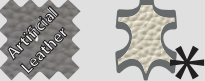

	 Basi - Bases	 Schienali - Backrests		
<b>Rivestimento Upholstering (10)</b>	Sfoderabile Removable 			
	Non sfoderabile Not removable 	-		
<b>Imbottiture Padding (3-4-5-6-7-8-9)</b>	 D.35kg/m³	 D.75/25kg/m²+zavorra		 Optional

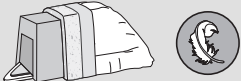
## INFORMAZIONI TECNICHE

### Struttura: 1

Masselli portanti in legno di abete. Elementi strutturali in pannelli di legno multistrati in classe E1, tamponamenti in faesite.

### Molleggio: 2

Seduta in nastri elastici di fibra propilenica e lattice incrociati e meccanicamente pretensionati.

### Note:

\* Per versioni in pelle contattare l'ufficio vendite.

L'ordine di ogni composizione deve sempre essere corredato da un disegno in pianta.

## TECHNICAL INFORMATION

### Structure: 1

Solid fir wood. Structural elements in multilayer wood panels in class E1, infills in faesite.

### Springing: 2

Seat with pre-tensioned crossed propylene fibre and latex elastic webbing.

### Note:

\* For the leather versions please contact the sales department.

For orders of compositions a sketch is requested.

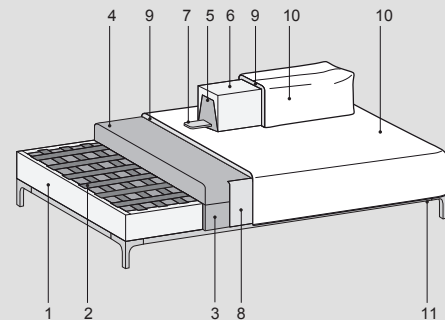
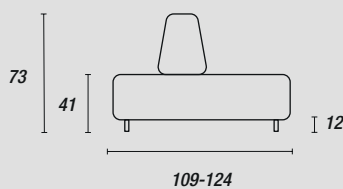

### Piedini - Feet:



Nero (ME09)  
Light brown (ME11)  
Antracite (ME01)  
Testa di moro (ME03)

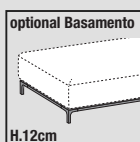

con maggiorazione  
Peltro (ME13)

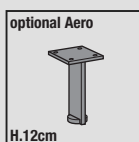





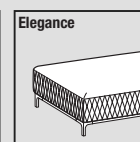
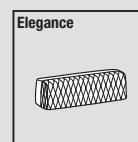





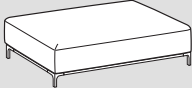

Nero (ME09)  
Light brown (ME11)

### Accessori - Accessories:

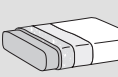

# Sanders air mix



	 Basi - Bases	 Schienali - Backrests		
<b>Rivestimento Upholstering (10)</b>	Sfoderabile Removable —	  		
	Non sfoderabile Not removable   	—		
<b>Imbottiture Padding (3-4-5-6-7-8)</b>	  D.35kg/m³	  D.75/25kg/m³+zavorra		 Optional

## INFORMAZIONI TECNICHE

### Struttura: 1

Masselli portanti in legno di abete. Elementi strutturali in pannelli di legno multistrati in classe E1, tamponamenti in faesite.

### Molleggio: 2

Seduta in nastri elastici di fibra propilenica e lattice incrociati e meccanicamente pretensionati.

### Note:

Base rivestita in tessuto e parzialmente rivestita in pelle Cat. Soft; per articolo imbottito con parti in pelle di altre categorie, aggiungere la maggiorazione indicata.

L'ordine di ogni composizione deve sempre essere corredato da un disegno in pianta.

## TECHNICAL INFORMATION

### Structure: 1

Solid fir wood. Structural elements in multilayer wood panels in class E1, infills in faesite.

### Springing: 2

Seat with pre-tensioned crossed propylene fibre and latex elastic webbing.

### Note:

Base upholstered in fabric and partially upholstered in leather Soft category; for the upholstery in other leather categories, please add the indicated increase in price.

For orders of compositions a sketch is requested.

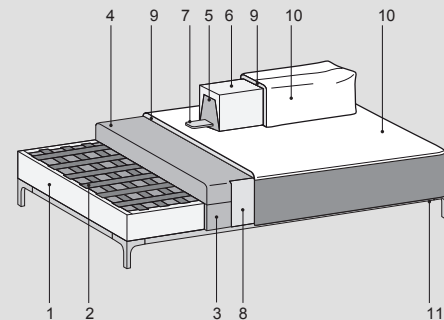
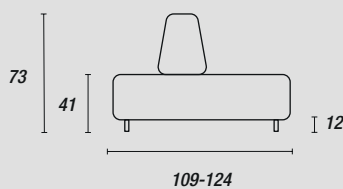

### Piedini - Feet:



Nero (ME09)  
Light brown (ME11)  
Antracite (ME01)  
Testa di moro (ME03)

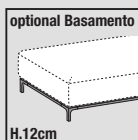

con maggiorazione  
Peltro (ME13)

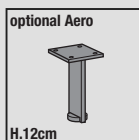

Nero (ME09)  
Light brown (ME11)

### Accessori - Accessories:

