









# Arlott high

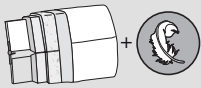

	Seat - Assise	Backrests - Dossiers	Structure - Structure	
<b>Upholstering</b> <b>Revetement</b> <b>(11)</b>	Removable <i>Déhoussable</i>	 		
	Not removable <i>Non déhoussable</i>	—		
<b>Padding</b> <b>Rembourrages</b> <b>(4-5-6-7-8-9-10)</b>	 D.35/40kg/m³	 D.21kg/m³	 Polyurethane foam	 optional

## TECHNICAL INFORMATION

### Structure: 1-2-4

Solid spruce and beech wood supports in various thicknesses. Buffer side in class E1 plywood and particleboard panels; details in hard or cellulose wood fibre panels.

### Springing: 1-3

The back is made of hard or cellulose wooden fibre panels.  
Seat with pre-tensioned crossed propylene fibre and latex elastic webbing.

### Note:

Chromed steel headrest (12) mechanism 6 positions adjustable with manual mechanism.

Metal front bar (14) available in black (ME 09) or light brown (ME 11) finishes or with leather upholstery in the various colors and types available in the color chart

## INFORMATIONS TECHNIQUES

### Structure: 1-2-4

Support en bois d'épicéa et de hêtre de différentes épaisseurs. Côtés de compensation en panneaux de contreplaqué de bois et panneaux de particules de bois de classe E1, détails en panneaux de fibre de bois dur ou cellulose.

### Suspension: 1-3

Dossier en panneaux de fibre de bois dure ou cellulose.  
Assise en rubans élastique de fibre propylène et latex croisés et mécaniquement pré-tensionnés.

### Note:

Mécanisme de la tète (12) en acier chromé avec 6 position de réglage avec mécanisme manuel.

Barre frontale (14) en métal disponible dans les finitions noir (ME 09) ou Light Brown (ME11) ou avec revêtement en cuir dans les couleurs et typologies qui sont disponibles sur le nuancier

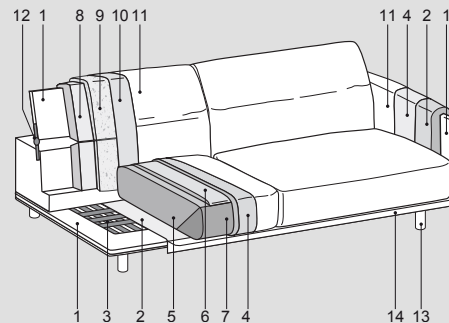
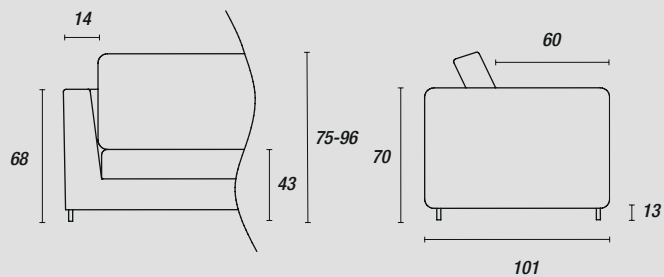

### Feet - Pieds::

#### standard Tail

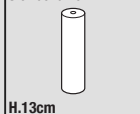

Black (ME09)  
Light brown (ME11)